

Original Implements™

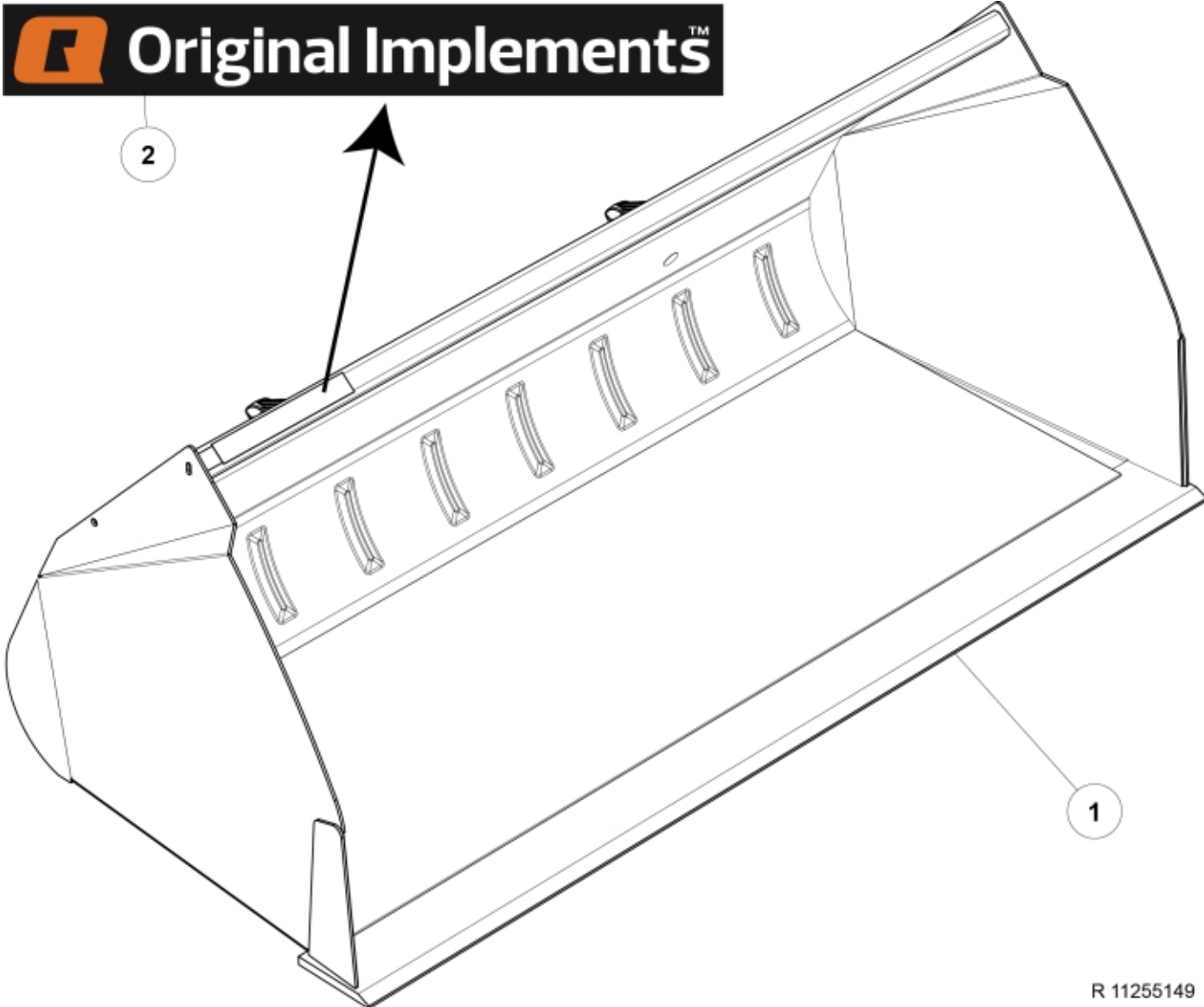

R 11255149

Part assemblies HXV Bucket 240
Specification Year From: 01/05/2018 00:00:00
Year To: 31/10/2020 00:00:00

PartNo	Pos	Qty	Name	Specifications
11255149		1	HXV Bucket 240	01/05/2018 00:00:00, 31/10/2020 00:00:00
11260042	1	1	Cutting edge	L=2450
11137127	2	1 PCS	Decal	"Original Implements"
5022119		2	Plug	