

Q Silograb® M+

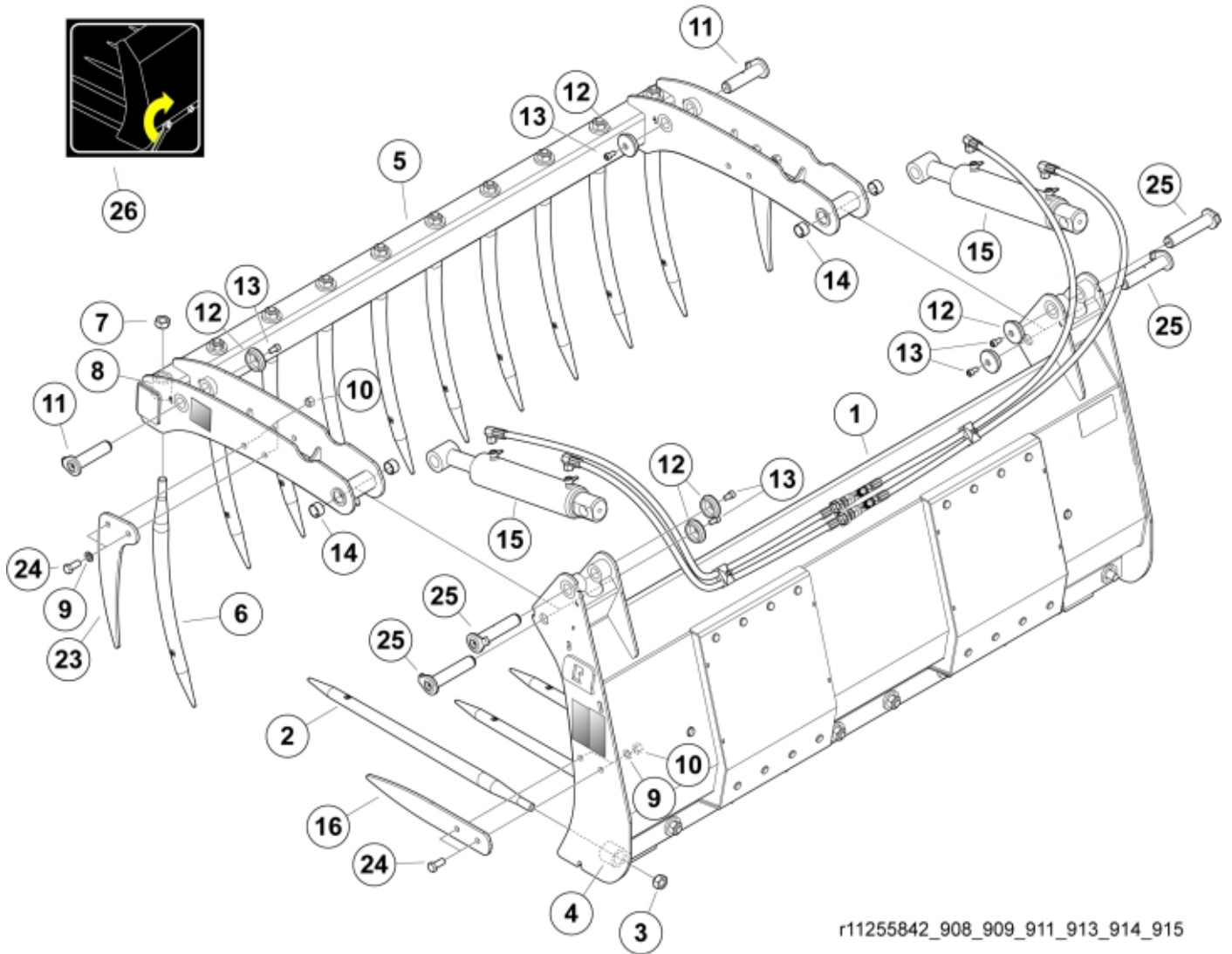
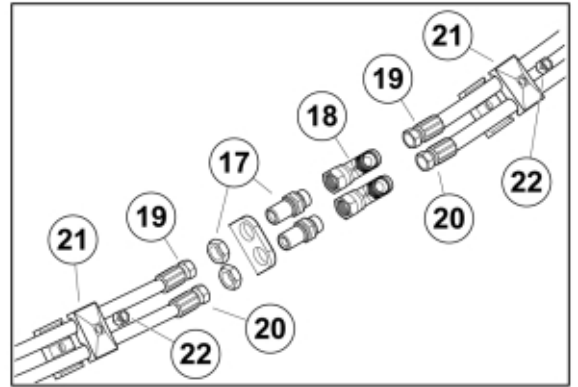

r11255842_908_909_911_913_914_915

Part assemblies		Silograb M+ 150		
Specification		Year From: 18/12/2020 00:00:00		
PartNo	Pos	Qty	Name	Specifications
11255908		1	Silograb M+ 150	18/12/2020 00:00:00
60054812-17	1	1	Frame, without tines	
5068109-17	2	8	Tine with nut	L=820mm (replaces 5068101)
5068111	3	1	• Nut	Conus 1
9010121	4	8	Sleeve	Conus 1
5022119		2	Plug	
11261853-17	5	1 PCS	Upper part, without tines	
5068112-17	6	8 PCS	Tine with nut	L=680, Curved
5068111	7	1	• Nut	Conus 1
9010120	8	8 PCS	Sleeve	Conus 1 Curved
5013107	9	8	Washer	BRB 15 x 26 x 2
5011556	10	8	Nut	M14
9020048	11	2 PCS	Pin	D=30mm, L=125mm
5215131	12	6	Locking cover	
5004917	13	6	Screw	
5018515	14	4	Bushing	D30 L=20
12711010-1	15	2	Cylinder	Glossy Black
11260256-22	16	2	Side tine	
11120580	17	2	Adapter cpl.	
5028031	18	2	T-Adapter	
60057097		1 PCS	Hose kit	
60057100	19	2 PCS	• Hose	3/8" L=1150 1/2GRLM 3/8G90LMC
60057099	20	2 PCS	• Hose	3/8" L=950 1/2GRLM 3/8G90LMC
5016968	21	2	Hose clamp	
5011553	22	2	Nut	M6M M8 Loc-king
11260312-22	23	2	Side tine	
5002127	24	8	Screw	M6S M14 x 35
9020047	25	2	Pin	D=30mm, L=151mm
11136517	26	1	Warning decal	"Tightening of tine"
1123674	27	1	Warning decal	"Read manual"
1123673	28	1	Warning decal	
60054809	29	1 PCS	Decal	Silograb M+
5022119		2	Plug	