

Q Multibenne™ M+

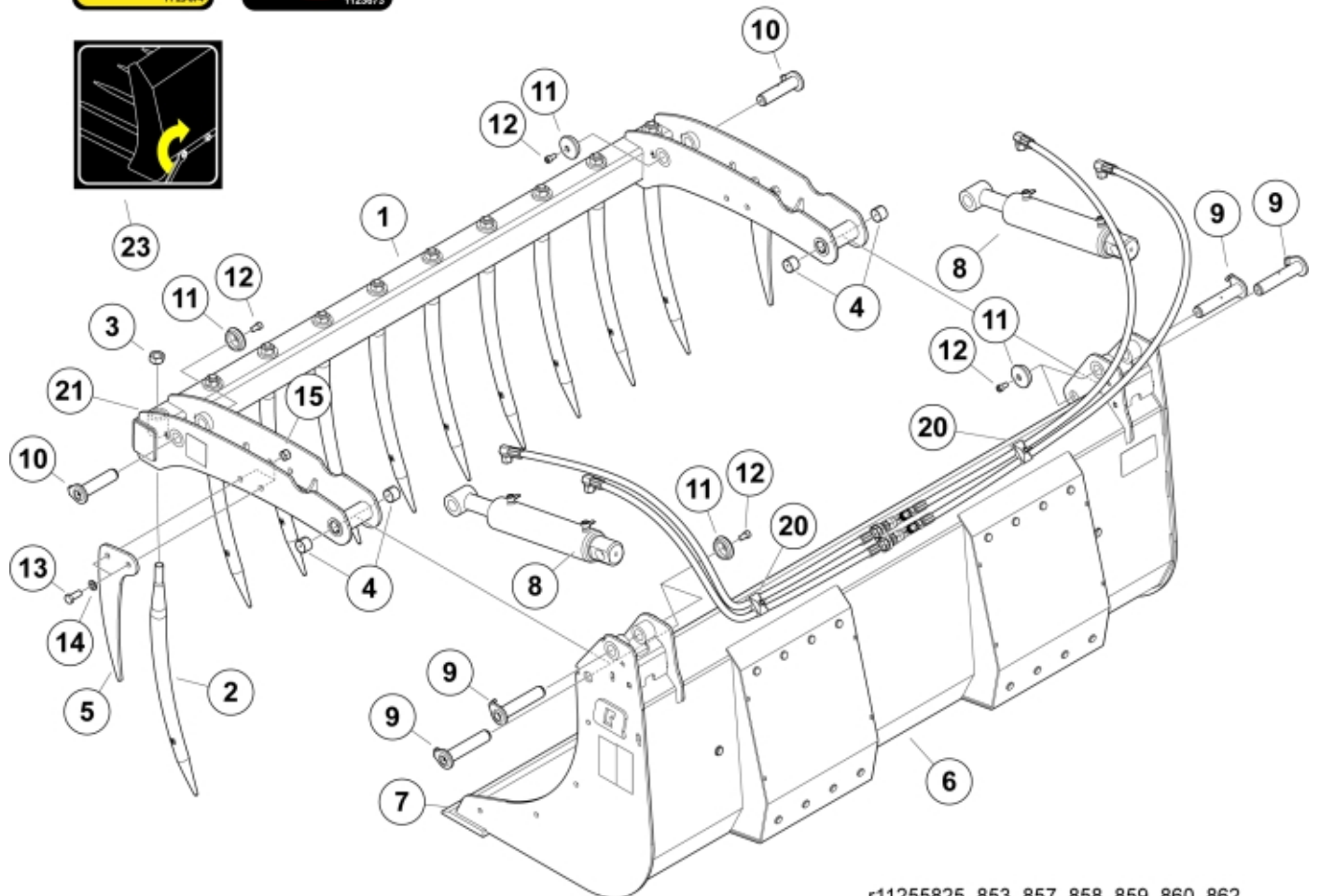
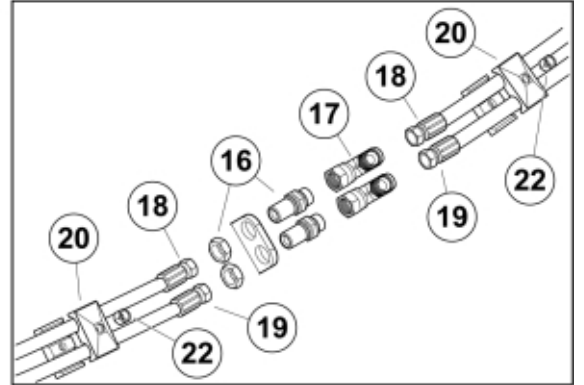

r11255825_853_857_858_859_860_862

Part assemblies		Multibenne M+ 170		
Specification		Year From: 18/12/2020 00:00:00		
PartNo	Pos	Qty	Name	Specifications
11261854-17	1	1 PCS	Upper part, without tines	
5068112-17	2	9 PCS	• Tine with nut	L=680, Curved
5068111	3	1	•• Nut	Conus 1
5018515	4	4	• Bushing	D30 L=20
11260312-22	5	2	Side tine	
60054537-17	6	1 PCS	Bucket	Multibenne M+ 170
5022119		2	• Plug	
60044747	7	1 PCS	Cutting edge	
12706410-1	8	2	Cylinder	Glossy Black
9020047	9	4	Pin	D=30mm, L=151mm
9020048	10	2 PCS	Pin	D=30mm, L=125mm
5215131	11	6	Locking cover	
5004917	12	6	Screw	
5002127	13	4	Screw	M6S M14 x 35
5013107	14	4	Washer	BRB 15 x 26 x 2
5011556	15	4	Nut	M14
11120580	16	2	Adapter cpl.	
5028031	17	2	T-Adapter	
60057103		1 PCS	Hose kit	
60057105	18	2	• Hose	3/8" L=1250 1/2GRLM 3/8G90LMC
60057104	19	2	• Hose	3/8" L=1050 1/2GRLM 3/8G90LMC
5016968	20	2	Hose clamp	
9010120	21	9 PCS	Sleeve	Conus 1 Curved
5011553	22	2	Nut	M6M M8 Loc-king
11136517	23	1	Warning decal	"Tightening of tine"
1123674	24	1	Warning decal	"Read manual"
1123673	25	1	Warning decal	
60054486	26	1 PCS	Decal	Multibenne M+
60056616	27	2	Decal	"Q" medium 110mm
5034439		2	Protection sleeve	