

M 59042200_1

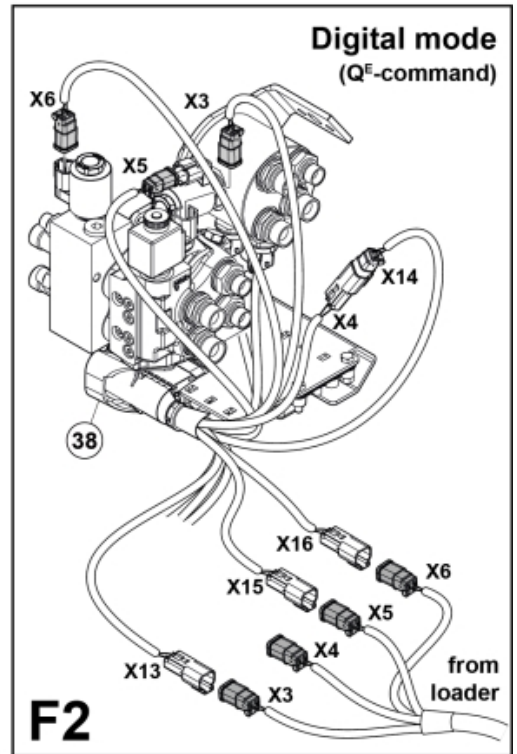

M 59042200_2

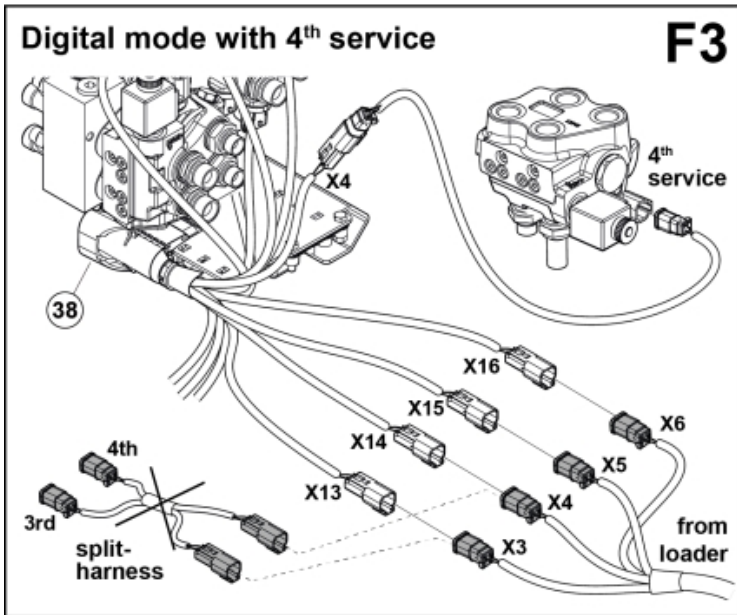
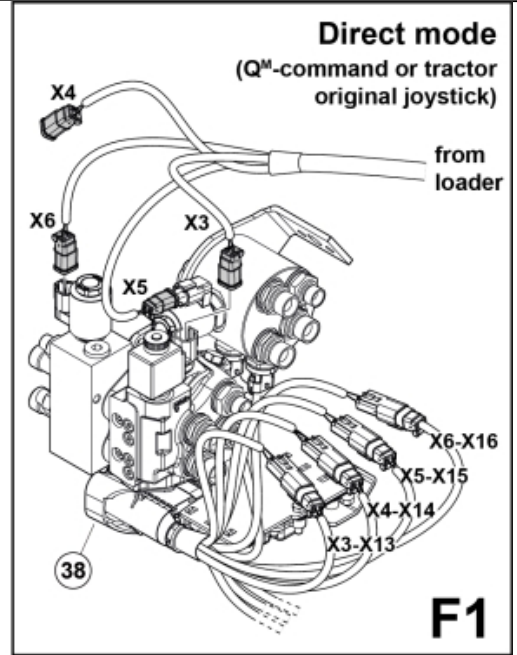
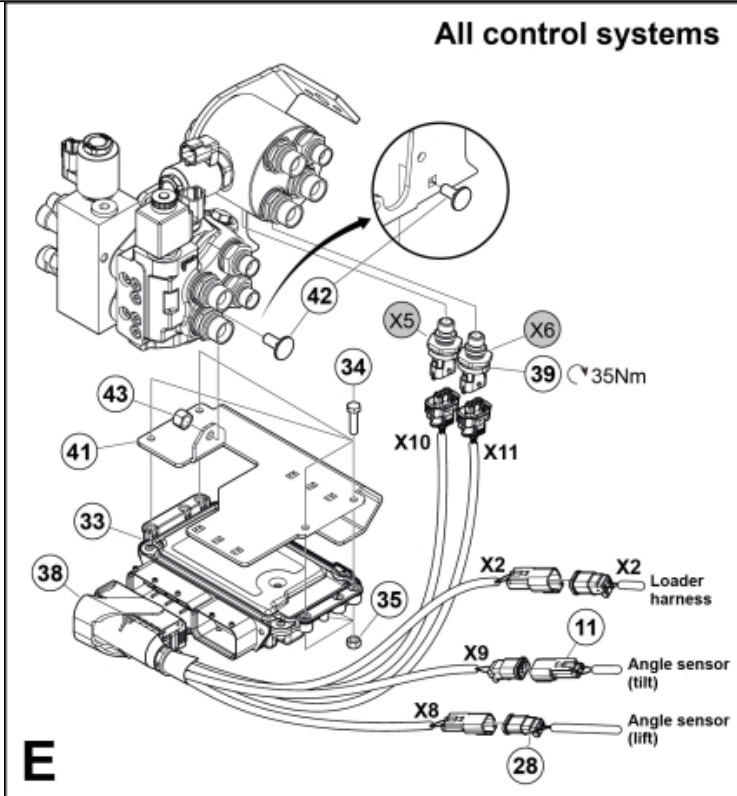
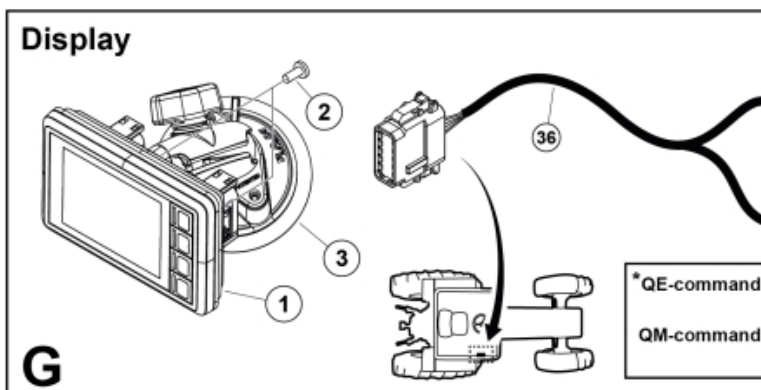

*QE-command: to display connector on tractor harness
QM-command: to display connector on harness (37)

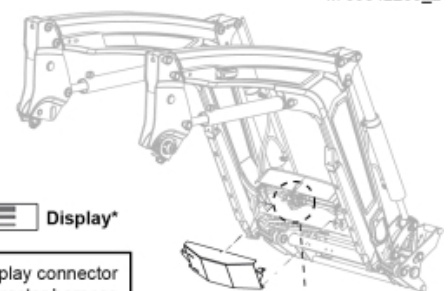

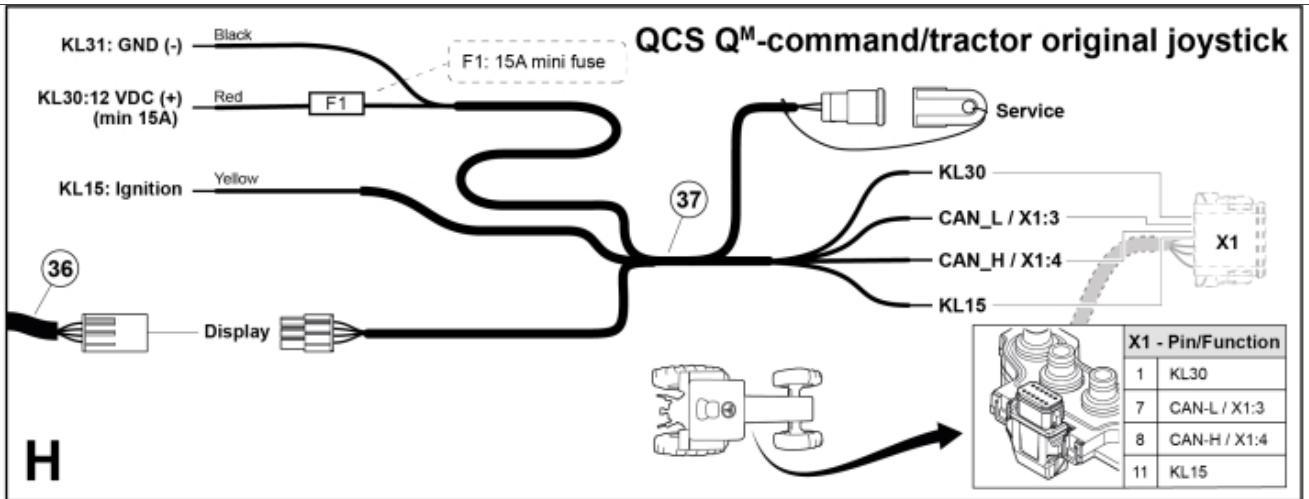

Product setup



Select language. Confirm to continue.

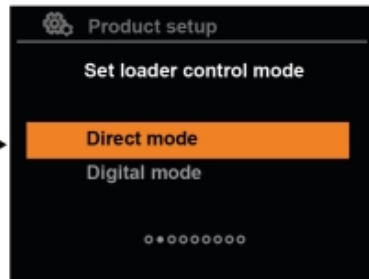

Select control mode. Digital mode is only in combination with QE-command. Confirm to continue.



Select loader type. Confirm to continue.



Select unit. Confirm to continue.

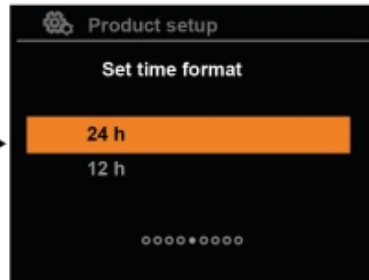

Select time format. Confirm to continue.



Adjust time. Confirm to continue.

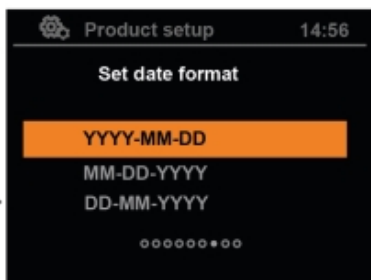

Select date format. Confirm to continue.



Adjust date. Confirm to continue.

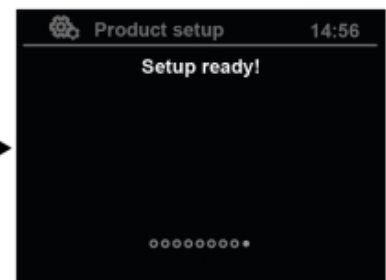

Confirm.

M 59042200_3

Description Display buttons right side of screen. Harness integrated in 12-pin Deutsch contact loader to tractor.
Part assemblies Q Companion QCS

PartNo	Pos	Qty	Name	Specifications
59040150	1	1	Display kit	
60007804	2	2	• Screw	MRX 4.8 fzb 5x12
60007807	3	1	Bracket	
60009447	4	1	Guide plate	
60103772	5	1	Bushing	
60007693	6	1	Washer	
60008010	7	1	O-ring	
60007071	8	1	Magnetic screw	M10 x 1,5
60012971	9	1	Screw	MC6S 8.8 fzb M10 x 60
60008281	10	1	Guide pin	
59040421	11	1	Angle sensor	Tilt
60010426	12	1	• Cover	
5050792	13	2	• Screw	ST3,5x13
60010159	14	2	Screw	MC6S 8.8 fzb M5x16
60008274	15	1	Protective frame	
5004935	16	2	Screw	MC6S M10 x25 (8.8)
5013110	17	2	Washer	BRB 10.5x22x2
60009767	18	2	Cable lock	
60007713	19	1	Guide plate	
60103772	20	1	Bushing	
60007693	21	1	Washer	
60008010	22	1	O-ring	
60007071	23	1	Magnetic screw	M10 x 1,5
60009767	24	1	Cable lock	
60103776	25	1	Guide pin	
5004077	26	1	Screw	MC6S M10 x 40
60010805	27	1	Washer	
59040411	28	1	Angle sensor	Lift
60010426	29	1	• Cover	
5050792	30	2	• Screw	ST3,5x13
60010159	31	2	Screw	MC6S 8.8 fzb M5x16
59040250	33	1	ECU kit	
5002027	34	4	• Screw	M6S_ M6 x 25 (8.8)
5011552	35	4	• Locking nut	M6 Locking
60026157	36	1	Harness	
59050105	37	1	Harness	
59050107	38	1	Harness	
59040400	39	2	Pressure sensor	
60037301	40	1	Decal	
60037964	41	1	Plate	
5006001	42	1	Screw	MVBF 8x20
5011553	43	1	Nut	M6M M8 Loc-king