

R 12704610

Part No
Best.nr.
Ref.No
Bestell Nr

Loctite
min 300 Nm

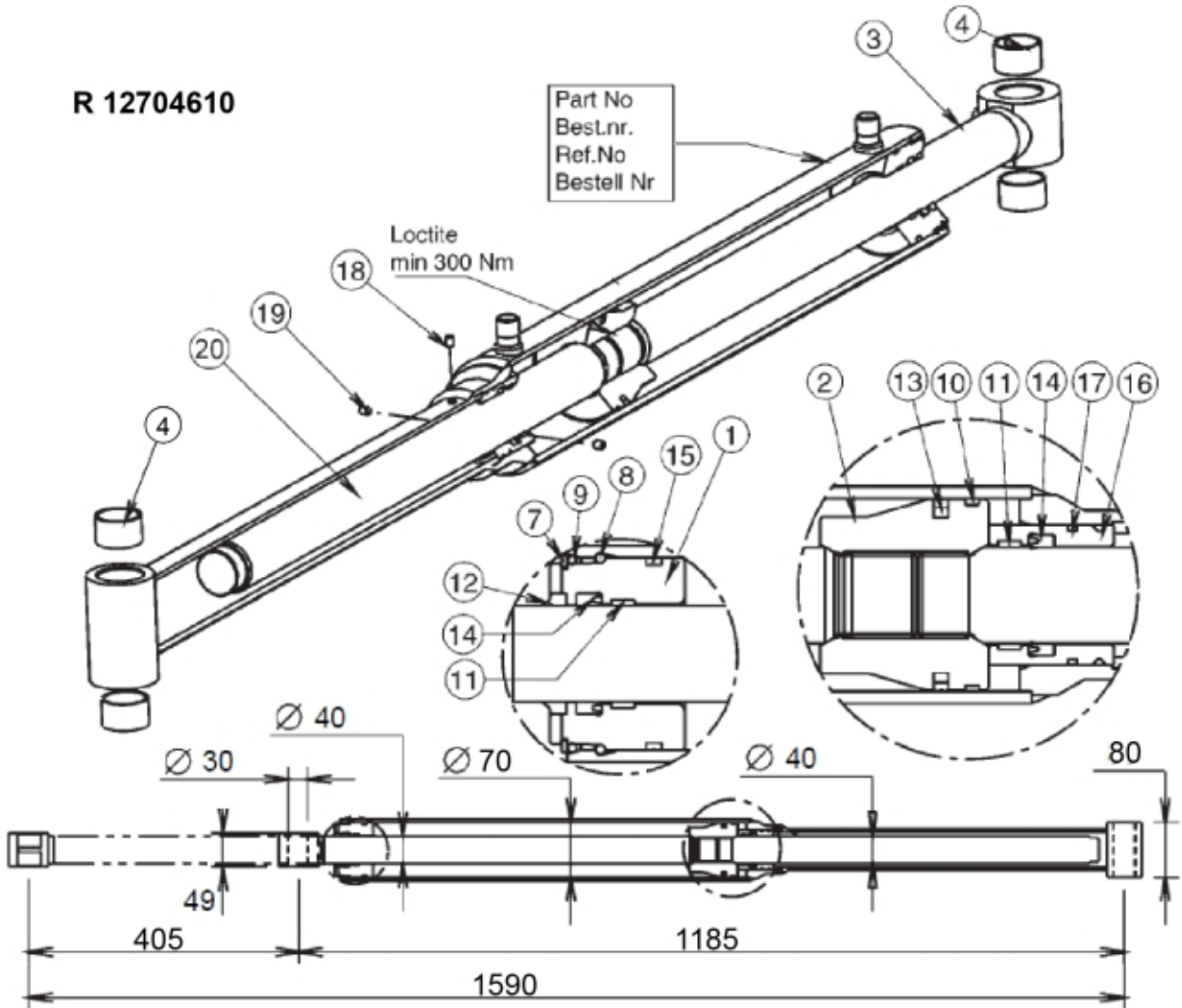

Description Ø 70/40/40 mm
Part assemblies Cylinder
Specification Year From: 1/1/2002 12:00:00 AM

PartNo	Pos	Qty	Name	Specifications
12707011	1	1	Bearing	D70/40 LH
12707012	2	1	Piston	D70
12704823	3	1	Piston rod	
5018515	4	4	Bushing	D30 L=20
5016621	7	1	Retaining ring	
5016669	8	1	Retaining ring	
12700017	16	1	Guide	
5005984	19	2	Stop screw	S6SS M6x8
12700715	20	1	Rear rod	
5033712		1	Seal kit	
5037243	9	1	• O-ring	63,09x3,53
5040013	10	1	• Guide ring	70/65x5,5
5040010	11	2	• Guide ring	40/45x9,7
5038101	12	1	• Wiper	40/50x7/10
5040023	13	1	• Piston seal	70/54,5x6,3
5038254	14	2	• Seal	40/50x10
5039003	15	1	• Cover seal	70 x 64,6 x 6,2
5039001	17	1	• Seal kit	58 x 53.4 x 4.1
5022095	18	1	• Plug	